

Tiger Industrial Winch Model No. SF-2200



Main Features

- 2200lb/1000kg lifting & 4400lb/2000kg pulling capacity
- Ratchet handle permits reciprocating handle movement in both directions for lifting and lowering loads
- Positive load-actuated brake can hold the load in any position
- Gears and brake are fully covered to prevent dust, dirt and rain contamination
- Very low operator effort is required for easy operation
- Ratchet handle accommodates installation in cramped locations
- Operating temperature -40°C to +80°C (temperature range of -60°C to +80°C available as an option)

Certification:

Each unit comes fully certified with a test certificate or an EC Declaration of Conformity stating compliance with the essential health and safety requirements of the Machinery Directive 2006/42/EC.

Technical Data

Product Code	Pulling Capacity (lbs/kg)	Lifting capacity (lbs/kg)	Hand Force Required (kg)	Gear Ratio	Hub Diameter (mm)	Handle Length (mm)	Unit Weight (with handle) (kg)	Cable Diameter (mm/inch)	Cable Storage Cap. (m)
SF-2200	4400/2000	2200/1000	10	22.2:1	ø80	300	17.5	ø8.0/ø5/16	32

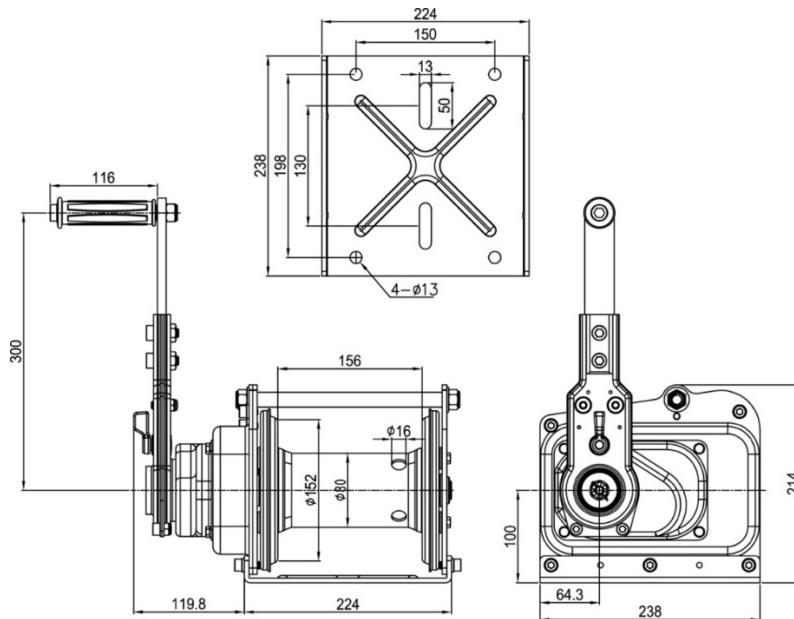

Due to our policy of continual product development, dimensions, weights and specifications may change without prior notice. Please check with your Tiger sales team when ordering.

Bespoke designs available on request – contact info@tigerlifting.com for more information.